



Glide Screw™

Combines the Features of a Linear Bearing and Screw in One Compact Package

Introduction

What is a Glide Screw™? Part linear bearing, part lead screw; a combination of two favorites to create something better than both. The patent-pending Glide Screw brings high performance, fast installation and less complexity in a small package.

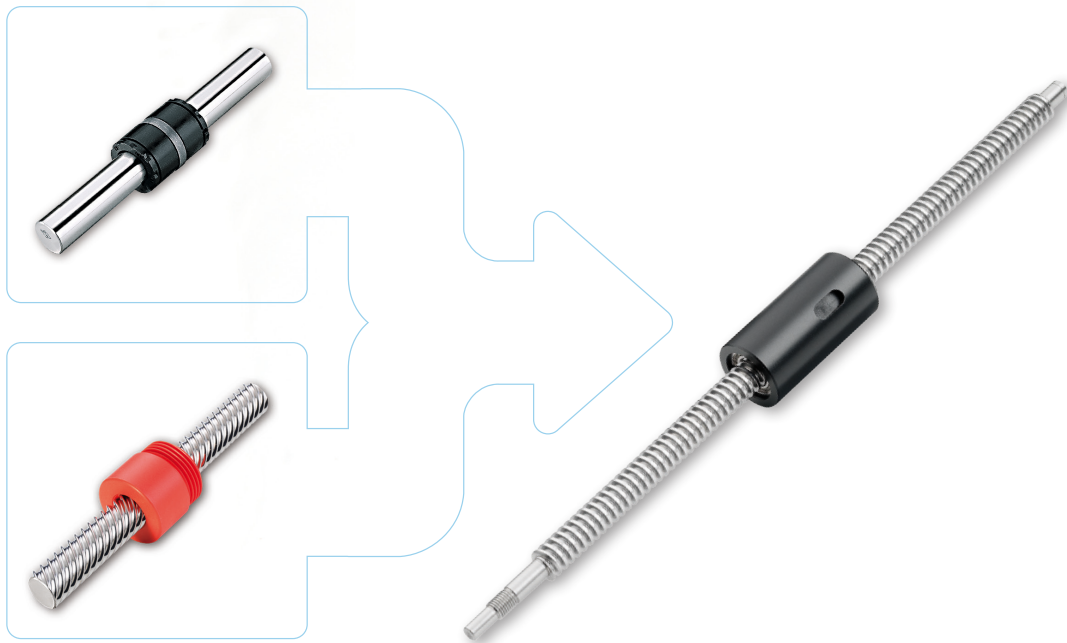

Standard Sizes and Configurations Stocked for Immediate Availability

- Metric Series includes 4, 6 and 10 mm nominal diameters
- Inch Series includes 3/16", 1/4" and 3/8" nominal diameters
- Flanged and cylindrical nut bodies standard

Optional Configurations for Harsh Environments Available

- High temperature resistant – inside ovens or autoclaves (up to 175 °C)
- Clean room – in robot vacuum chambers, laboratories or medical equipment (ISO 6)
- Food grade – in packaging and food processing equipment

Custom Nut Configurations, Screw Diameters and Thread Leads Available

- Don't see your perfect configuration – call us, we make custom sizes

Easy to Install and Maintenance Free!

- All that is required is a Glide Screw and an anti-rotation feature
- No need for reference surfaces or the pain of "floating" your system into alignment
- Plug and play – install it and forget it
- Integrated Thomson's patented Lube for Life technology
- Bearing grade plastic and stainless steel construction standard

Benefits of the Glide Screw Technology

The Glide Screw combines the features of a linear bearing and a lead screw in one smooth operating package. Inch and metric sizes are standard. Custom sizes are also available quickly and to your specification.

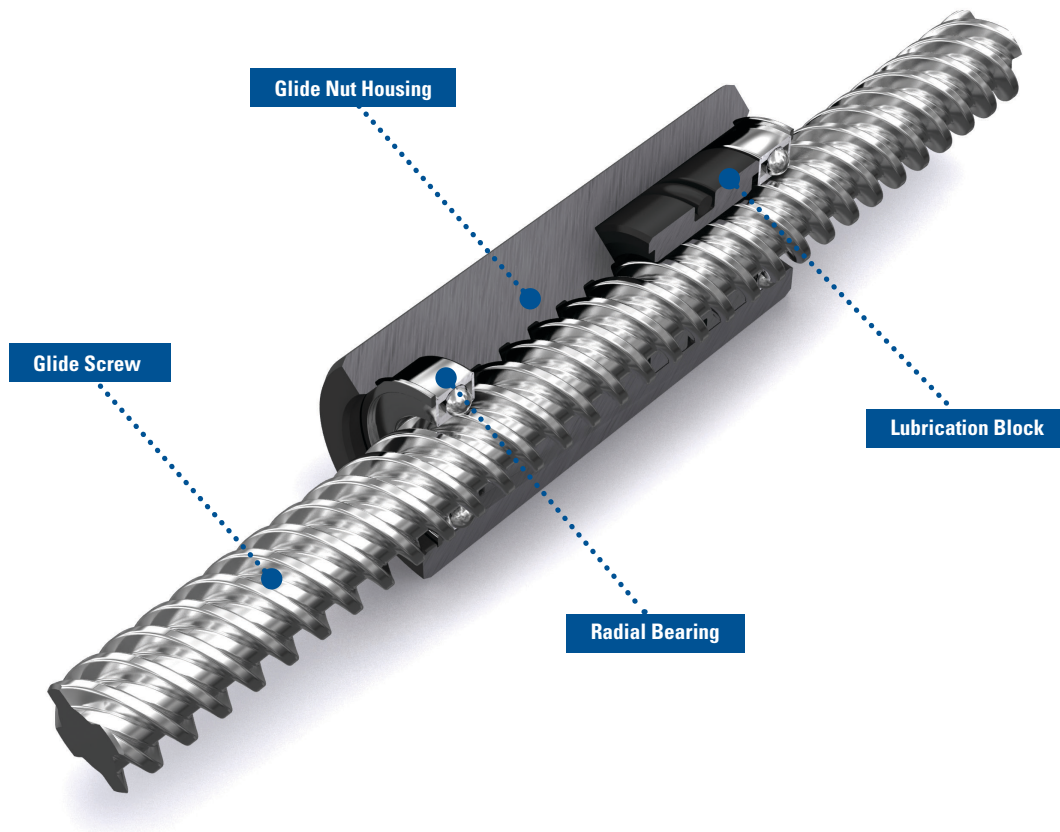

Reduced Footprint

- Integrated lead screw / linear bearing
- Side load / moment load capable

Improved Equipment Uptime

- Screw and linear bearing are already aligned
- Component alignment is not critical – smooth and quiet motion
- Integrated lubrication block – Thomson Lube for Life standard

Lower Cost of Ownership

- Less complexity – faster installation
- Less components – simpler bill of material
- Maintenance free – no lubrication required

Typical Application

Every engineer's objective is to eliminate parts, streamline the design, simplify installation and reduce the maintenance required – exactly what a Glide Screw™ does.

3D Printing or Engraving

Innovative and portable multi-axis printers / engravers are revolutionizing rapid prototyping and consumer products. The Glide Screw can reduce the number of components, decrease system complexity, decrease assembly time and produce a better machine as described in the table below. It requires no maintenance, can shorten overall guided length and has a longer life which makes our Thomson Glide Screw the better design solution and less expensive overall.

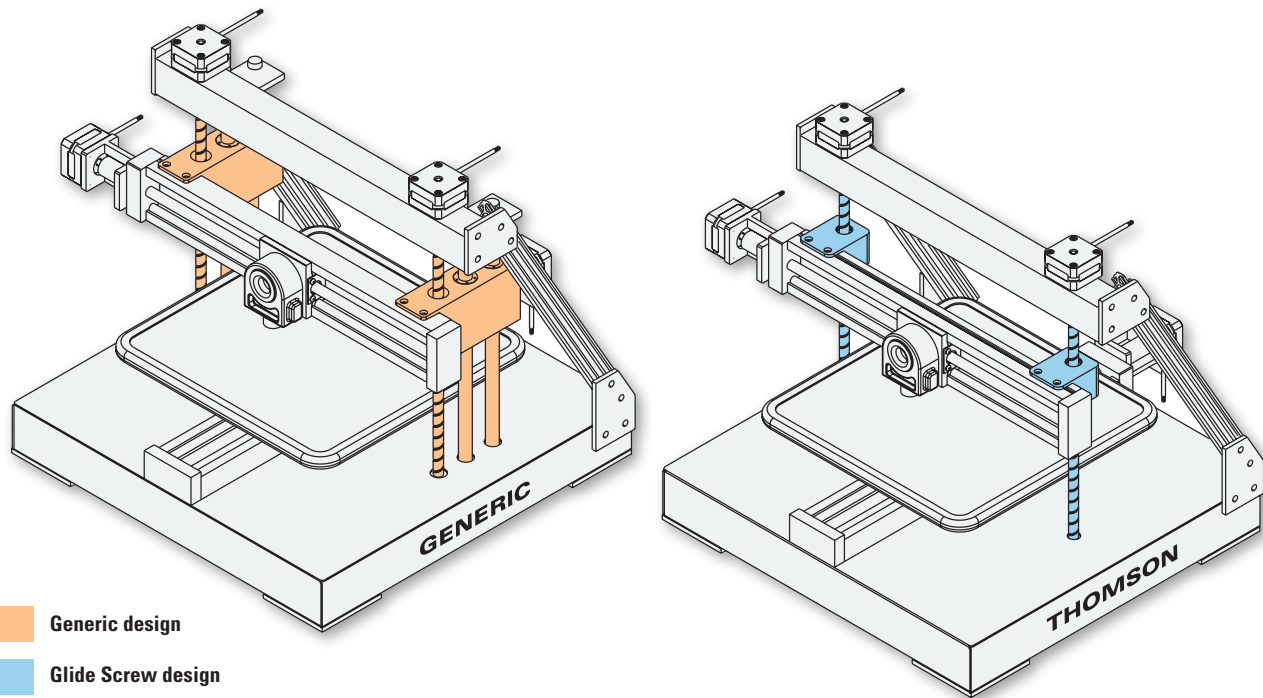

Generic vs. Glide Screw Design		
	Generic	Glide Screw
X, Y Area Compactness	4100 mm ²	1600 mm ²
Z Axis Length	64 mm	46 mm
Approx. Installation Time	45 min	15 min
Number of Parts	74	30
Self Aligning	No	Yes
Maintenance Free	No	Yes

Other Application Ideas

Fluid Pumps

Syringe pumps and integrated fluid pumps are a growing segment of the medical industry. The stringent demands of these customers require smaller, cleaner, smoother, and quieter products. This is exactly the challenge the Glide Screw was designed to solve.

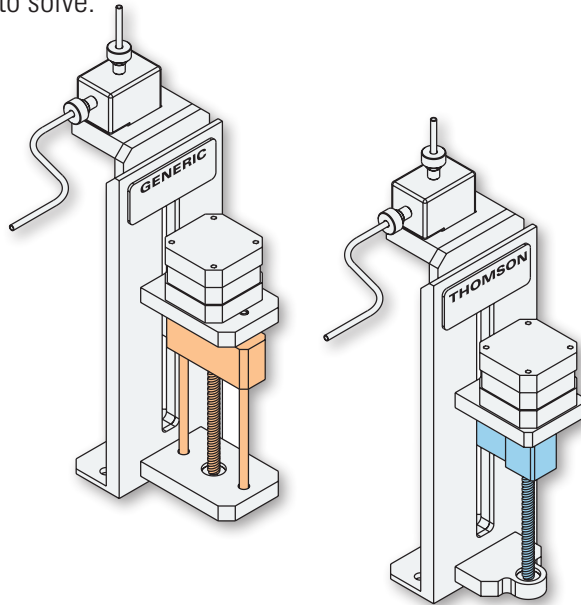

Fluid Pipetting / 3-Axis Lab Automation

Lab automation and diagnostics require faster and more accurate systems in smaller footprints. Optimized for z-axis applications requiring the smallest footprint, the Glide Screw can replace traditional linear guided products that are oversized and more expensive.

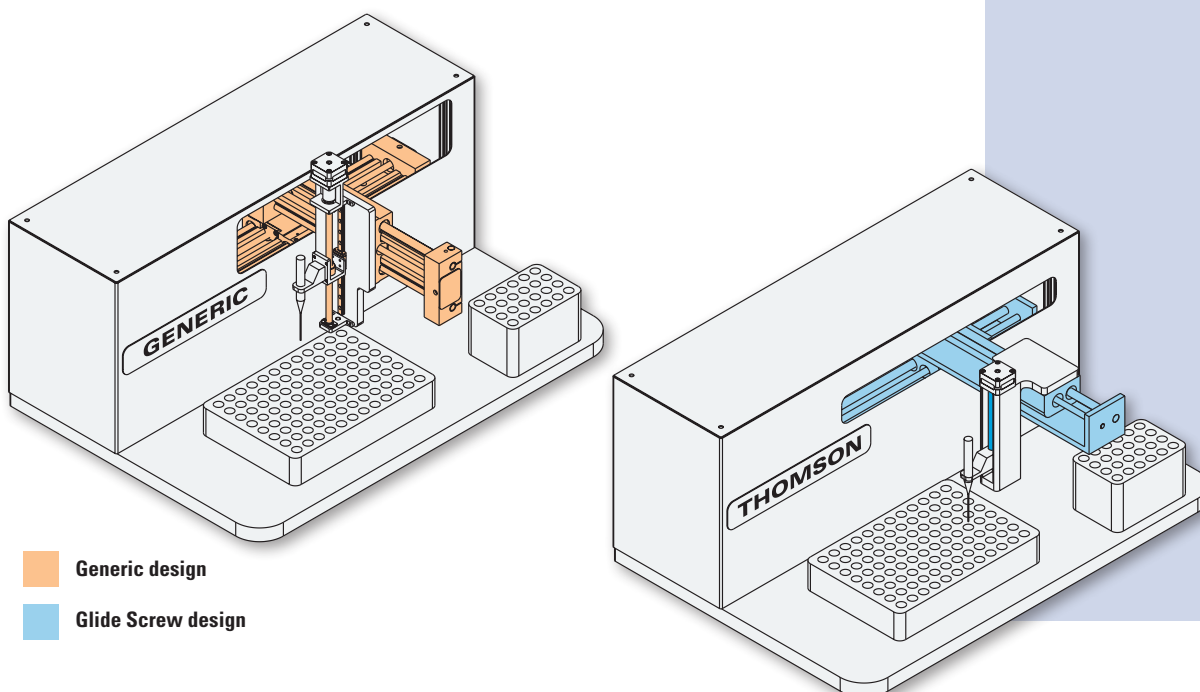

Other Applications

The Glide Screw improves performance in a smaller and lighter package. It is easier and faster to install. Also, it requires less maintenance compared to traditional lead screw and linear guide solutions. Other great applications for the Glide Screw include:

- Test tube handling
- Lab automation
- CD duplication
- Pick & place
- Syringe pumps
- In vitro diagnostics
- Medical imaging

Engineering

The Glide Screw™ is designed to actuate a moment load or a side load without additional linear guidance or support. Therefore, the screw deflection is the determinant feature and the following charts must be used when properly sizing a Glide Screw for an application.

How the Glide Screw Works

The unique design of Glide Screw allows it to handle axial, radial and moment loads without additional guidance. The result is an efficient and space saving design that is quick and easy to install with reduced maintenance needs compared to traditional solutions.

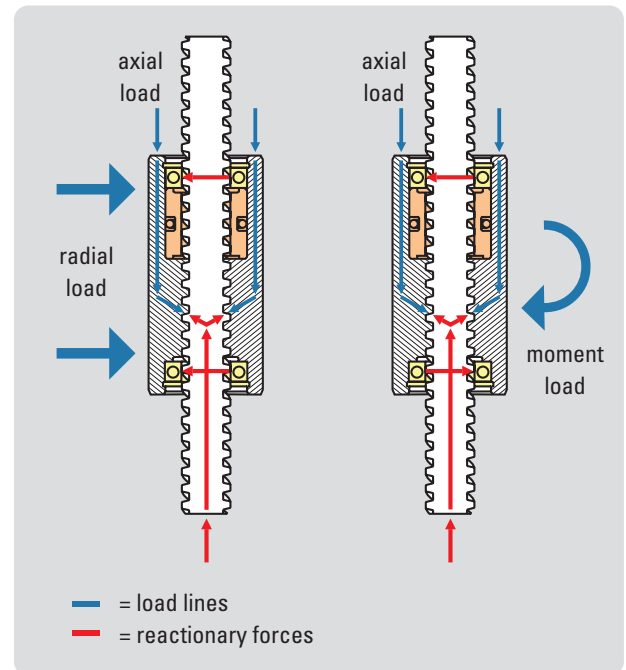

End Support

Decide which type of end support you will use to enable accurate selection of diameter.

Fixed support – utilizes a support journal length at least $1.5 \times$ the journal diameter – such as dual ball bearings.

Simple support – uses a single ball bearing, a plain bearing, or a bushing.

End support configurations shown at left:

1. Simple / simple
2. Fixed / simple
3. Fixed / fixed

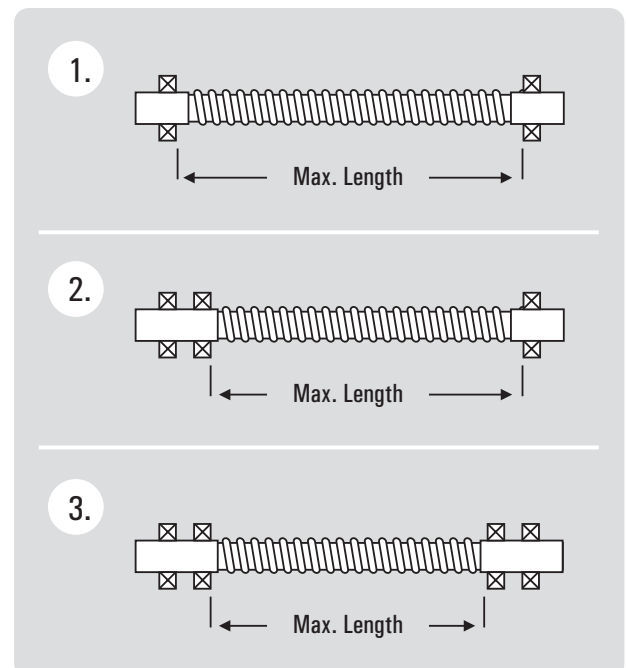

Engineering

Moment Load and Radial Load Charts

Determine your end support configuration and then use the following charts to properly size the nominal diameter of the Glide Screw. Select a product diameter that lies above and/or to the right of the design moment or load.

The lead of a Glide Screw is defined as the axial distance traveled for one revolution of the screw. Select the appropriate lead of your screw based on the desired speed and resolution of travel. Note that the Glide Screw is limited to 300 RPM.

Inch Diameter Models

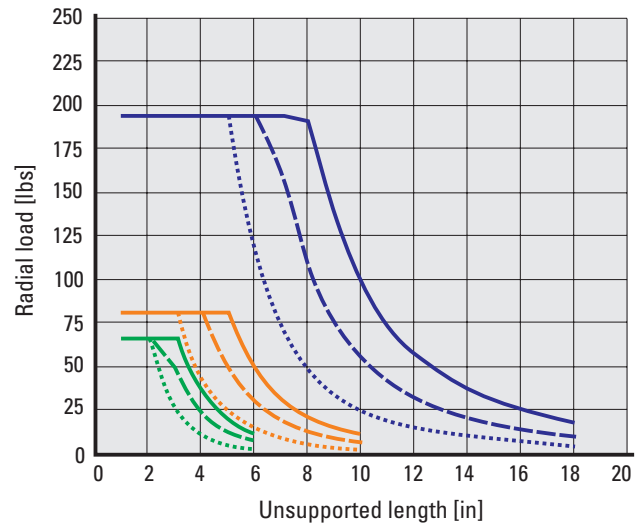
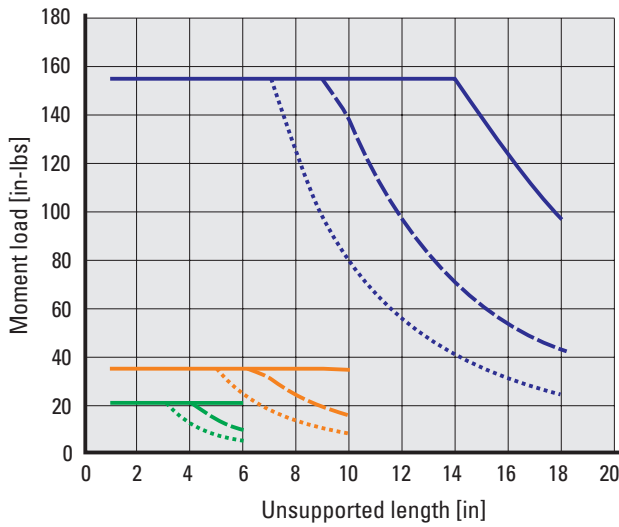

Metric Diameter Models

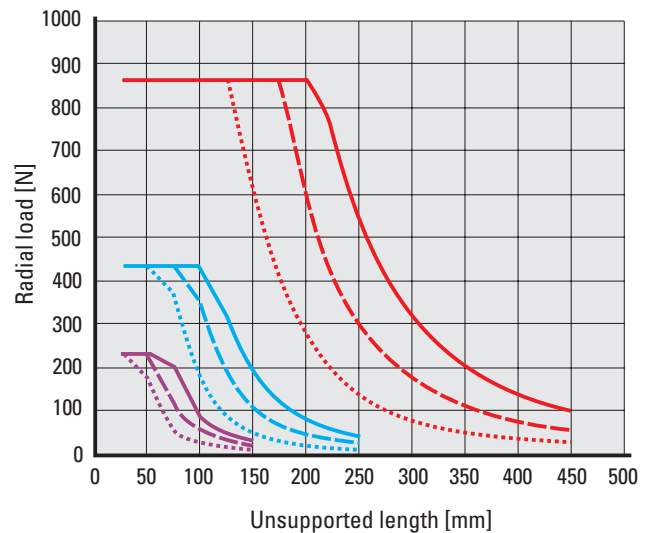
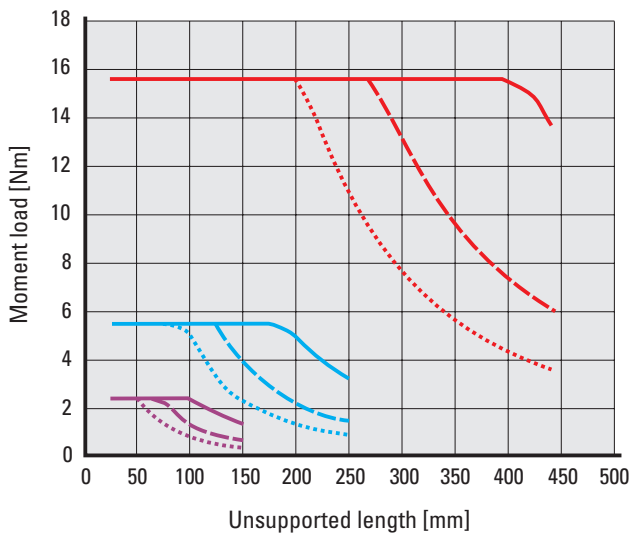

Screw diameters

- = 0.375 inch
- = 0.250 inch
- = 0.188 inch
- = 10 mm
- = 6 mm
- = 4 mm

End support type

- = fixed in both ends
- = simple in one end and fixed in other
- = simple in both ends

Conversion factors

- 1.0 in-lb = 0.113 Nm
- 1.0 lb = 4.448 N

Specifications and Part Numbers

Glide Screw™ configurations

GSF - screw and flanged nut assembly

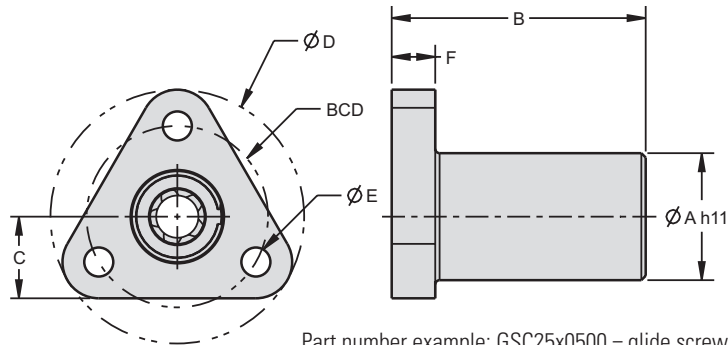

GSC - screw and cylindrical nut assembly

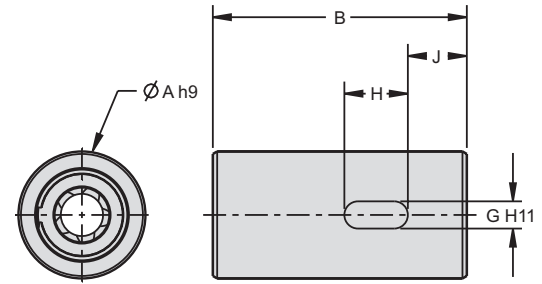

Part number example: GSC25x0500 = glide screw assembly, cylindrical nut, 0.250 inch diameter by 0.500 inch lead

Inch Series Dimensions																
Screw Diam. [in]	Screw Lead [in]	Screw and Nut Assembly Part No.	Max Axial Load [lbs]	Max Moment Load [in-lbs]	Max Screw Length [in]	Dimensions [in]										Effic. [%]
						A	B	C	D	E	F	G	H	J	BCD	
0.188	0.050	GS_18x0050	30.0	20.5	6.000	0.375	0.750	0.281	0.875	0.140	0.125	0.094	0.188	0.177	0.625	46
	0.125	GS_18x0125				68										
0.250	0.050	GS_25x0050	45.0	47.5	10.000	0.500	1.000	0.313	1.000	0.140	0.150	0.125	0.250	0.237	0.750	40
	0.500	GS_25x0500				82										
0.375	0.063	GS_37x0063	70.0	137.5	18.000	0.875	1.750	0.563	1.750	0.200	0.300	0.188	0.438	0.406	1.250	36
	0.500	GS_37x0500				78										
	1.000	GS_37x1000				83										

Metric Series Dimensions																
Screw Diam. [mm]	Screw Lead [mm]	Screw and Nut Assembly Part No.	Max Axial Load [N]	Max Moment Load [Nm]	Max Screw Length [mm]	Dimensions [mm]										Effic. [%]
						A	B	C	D	E	F	G	H	J	BCD	
4	1	GS_4x1M	89.0	2.3	150	10	20	6.5	20	2.5	3	2	5	5	15	45
	4	GS_4x4M				75										
	8	GS_4x8M				82										
6	1	GS_6x1M	133.4	5.4	250	13	26	7.75	25	3.5	4	3	7	5.75	19	36
	6	GS_6x6M				75										
	12	GS_6x12M				82										
10	2	GS_10x2M	311.4	15.5	450	22	44	14	44	5	7	4	10	9.85	32	40
	6	GS_10x6M				66										
	12	GS_10x12M				77										

Standard Products

- Acetal nut body with all stainless steel internal components
- 303 stainless steel screw
- Integrated Lube for Life lubrication block
- Temperature Rating: -40° to 65°C (-40° to 150°F)
- Clean Room ISO 7 (Class 10000)

End Machining

Recommended end machining

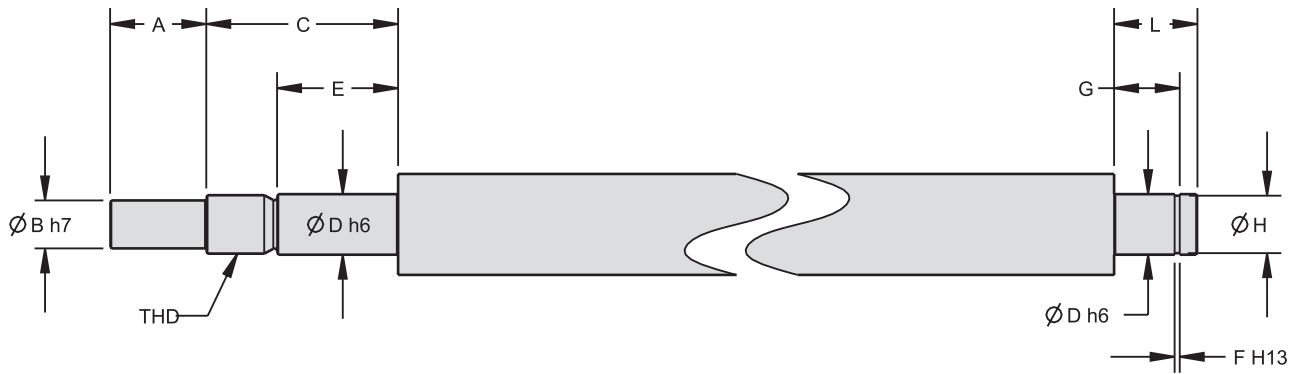

End support type

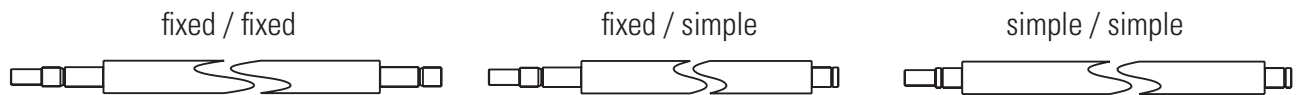

Inch Series End Machining Dimensions																	
Screw Diam. [in]	Screw Lead [in]	Screw Part No.	Root Diameter [in]	Recommended Bearing				Dimensions [in]									
				OD [mm]	ID [mm]	W [mm]	Bearing Trade No.	A	B	C	D	E	F	G	H	L	THD
0.188	0.050	GS18x0050	0.12	7	2.5	2.5	692X	0.197	0.098	N/A	0.098	N/A	0.022	0.120	0.075	0.157	N/A
	0.125	GS18x0125	0.13														
0.250	0.050	GS25x0050	0.19	13	4	5	624	0.295	0.118	0.610	0.157	0.374	0.020	0.217	0.150	0.256	M4xx0.5
	0.500	GS25x0500	0.16														
0.375	0.063	GS37x0063	0.30	19	6	6	626	0.394	0.197	0.728	0.236	0.453	0.030	0.266	0.220	0.315	M6x0.75
	0.500	GS37x0500	0.27														
	1.000	GS37x1000	0.24														

Metric Series End Machining Dimensions																	
Screw Diam. [mm]	Screw Lead [mm]	Screw Part No.	Root Diameter [mm]	Recommended Bearing				Dimensions [mm]									
				OD [mm]	ID [mm]	W [mm]	Bearing Trade No.	A	B	C	D	E	F	G	H	L	THD
4	1	GS4x1M	2.8	7	2.5	2.5	692X	5.00	2.50	N/A	2.50	N/A	0.55	3.05	1.90	4.00	N/A
	4	GS4x4M	2.8														
	8	GS4x8M	2.8														
6	1	GS6x1M	4.6	13	4	5	624	7.50	3.00	15.50	4.00	9.50	0.51	5.51	3.81	6.50	M4xx0.5
	6	GS6x6M	4.4														
	12	GS6x12M	4.4														
10	2	GS10x2M	7.3	13	6	6	626	10.00	5.00	18.50	6.00	11.50	0.76	6.76	5.59	8.00	M6x0.75
	6	GS10x6M	8.4														
	12	GS10x12M	8.4														

Installation

Comparing Alternative Technologies

The Glide Screw™ is both drive system and linear guide, so these features are already perfectly aligned and cannot bind. Therefore, installation is simple and the mating components do not require high tolerance geometric features.

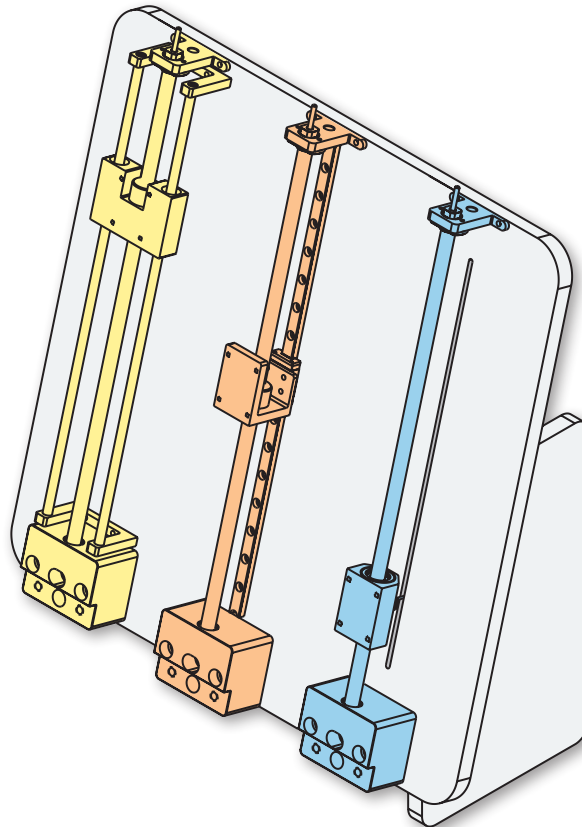

Drive and Guide Technology Comparison			
Feature	Lead Screw / Linear Bearings	Lead Screw / Profile Rail	Glide Screw
Small Footprint	Good	Better	Best
Ease of Installation	Better	Good	Best
Stiffness	Better	Best	Good
Misalignment Tolerant	Better	Good	Best
Lube for Life Lubrication	Optional	Optional	Integrated
Total Cost of Ownership	Good	Better	Best

Installation

Basic Installation Guidelines

The success of the Glide Screw in an application is primarily dependent on the end support configuration. Since the Glide Screw is a combination of a lead screw and linear bearing, the ability to handle non-axial loads while maintaining positional accuracy is the key to a successful installation. The load capacity curves are based on screw deflection and not the lead nut capacity. Therefore, stiffness of the assembly determines load capacity.

Installation Step-by-Step

1. Select end support configuration

A fixed bearing support should be selected when possible. A simple support is typically a single radial bearing that is allowed to float axially to compensate for misalignments. Typical methods of attaching end supports is either base mounting or flange mounting.

2. Select motor and drive configuration

Select a motor and your means for coupling the screw to the motor. Typically this is done by a belt, gearing or an in-line coupler. It is also possible to directly integrate a Glide Screw with a stepper motor, which can reduce complexity and save space.

3. Select nut mounting interface

The standard configurations for the glide nut are flanged nuts and cylindrical nuts but are by no means the only solutions. Custom configurations, custom mounting and design assistance are available from Thomson.

4. Determine anti-rotation method

The Glide Screw requires an external anti-rotation feature on the nut housing to function correctly. Two examples of acceptable methods are the finger / slot solution or the bushing / linear shaft solution.

5. Mount the assembly into the application

The actual mounting of the Glide Screw is easy once all of the peripherals have been determined and designed. Just bolt the assembly in place and fire up the system. No critical alignment procedures are necessary as the drive system and linear guidance are already in perfect alignment.

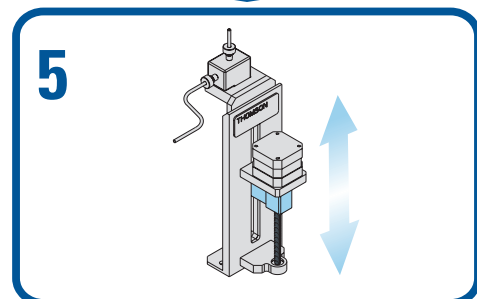
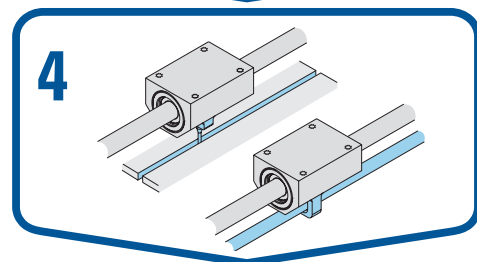
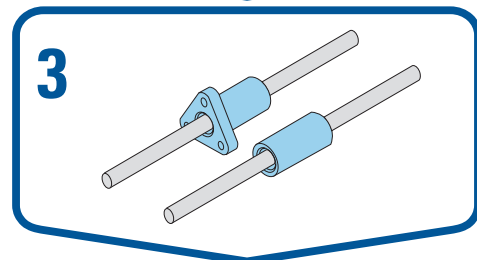
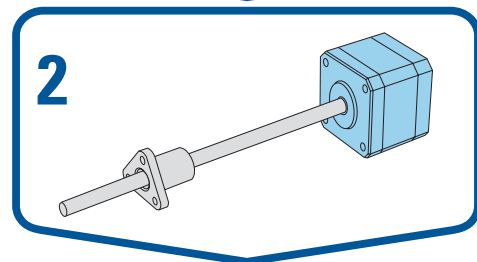
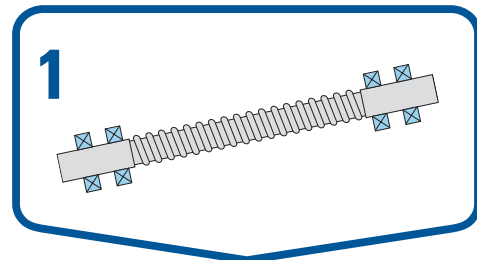

USA, CANADA and MEXICO

Thomson
203A West Rock Road
Radford, VA 24141, USA
Phone: 1-540-633-3549
Fax: 1-540-633-0294
E-mail: thomson@thomsonlinear.com
Literature: literature.thomsonlinear.com

EUROPE

United Kingdom

Thomson
Office 9, The Barns
Caddsdow Business Park
Bideford, Devon, EX39 3BT
Phone: +44 (0) 1271 334 500
E-mail: sales.uk@thomsonlinear.com

Germany

Thomson
Nürtinger Straße 70
72649 Wolfschlügen
Phone: +49 (0) 7022 504 0
Fax: +49 (0) 7022 504 405
E-mail: sales.germany@thomsonlinear.com

France

Thomson
Phone: +33 (0) 243 50 03 30
Fax: +33 (0) 243 50 03 39
E-mail: sales.france@thomsonlinear.com

Italy

Thomson
Largo Brughetti
20030 Bovisio Masciago
Phone: +39 0362 594260
Fax: +39 0362 594263
E-mail: sales.italy@thomsonlinear.com

Spain

Thomson
E-mail: sales.esm@thomsonlinear.com

Sweden

Thomson
Estridsväg 10
29109 Kristianstad
Phone: +46 (0) 44 24 67 00
Fax: +46 (0) 44 24 40 85
E-mail: sales.scandinavia@thomsonlinear.com

ASIA

Asia Pacific

Thomson
E-mail: sales.apac@thomsonlinear.com

China

Thomson
Rm 2205, Scitech Tower
22 Jianguomen Wai Street
Beijing 100004
Phone: +86 400 6661 802
Fax: +86 10 6515 0263
E-mail: sales.china@thomsonlinear.com

India

Thomson
c/o CNRG Energy India Pvt. Ltd.
Unit No. FF A 07
Art Guild House, A Wing, 1st Floor, L.B.S Marg
Kurla – West, Mumbai – 400070 India
Phone: +0091 22 6249 5043
Email: sales.india@thomsonlinear.com

Japan

Thomson
Minami-Kaneden 2-12-23, Suita
Osaka 564-0044 Japan
Phone: +81-6-6386-8001
Fax: +81-6-6386-5022
E-mail: csjapan@scgap.com

South Korea

Thomson ROA
704 ASEM Tower (Samsung-dong)
517 Yeongdong-daero, Gangnam-gu
Seoul, S. Korea, Zip Code: 06164
Phone: +82 2 6917 5048 & 5049
Fax: +82 2 528 1456 & 1457
E-mail: sales.korea@thomsonlinear.com

SOUTH AMERICA

Brazil

Thomson
Av. Tamboré, 1077
Barueri, SP - 06460-000
Phone: +55 11 3616-0191
Fax: +55 11 3611 1982
E-mail: sales.brasil@thomsonlinear.com